

Features/Functions/Benefits

Product Benefits & Solutions

- Patented visual display options integrated into casegoods
- Unique, multifaceted solutions for all types of learning environments
- Durable high pressure laminate work surfaces
- Thermofused laminate bases with flat PVC edge banding
- Effective solutions for both students and instructors
- Variety of sizes to fit any room layout
- ADA compliant desks available
- Total Access™ removable modesty panels for access to computer cabling
- Wire management system and power strip included
- Extensive array of filing and storage options
- Wide range of standard laminate colors available
- Edge banding colors to match all standard laminate colors
- Made in the U.S.A.

How To Order

1. Select model number

Ex: 85-SD243630RX

- A select offering of **left-handed units** are listed. For additional left-handed units, call Customer Support: 1-800-730-6682
- For **ADA Height** unit, change height from 30 to **32** in model number and add \$80 for single desk and \$120 for double desk. Ex: 85-SD2436**32**RX

2. Select laminate base and work surface color (see page 144)

Ex: 227 044
 Base Work
 Surface

3. Optional-Select visual display options (see page 115)

Ex: TH0721NK (The Trolley H-Class with Nova keyboard drawer)

4. Optional-Select essential accessory options (see page 34)

Ex: 11205DP (Standard data port)

- All locking units can be keyed alike. Please note on purchase order.

Visual Display Options To order, see page 115.

The Trolley™ Personal Monitor Arm System

Maximum dimensions for flat panel display:

E-Class: 2¾" D x 18½" W x 14" H (70mm D x 470mm W x 356mm H)

H-Class: 2¾" D x 16¼" W x 14" H (70mm D x 413mm W x 356mm H)

NOTE: Maximum distance from center of wall mount VESA plate to bottom of monitor is 6¾" (171mm)

- Provides flexible, mainstream flat screen location when raised
- Low voltage motor to lift and lower monitor
- Intelligent Motion Technology™ provides operational intuition
- Clears line-of-sight when submerged
- Allows for multi-use workstations and classrooms
- Keyed lock provides added security and control in any environment
- Hides confidential information when necessary
- Reduces the risk of damage to flat panels displays when stored
- Provides clean, ergonomical solutions
- Manage technology in your workspace environment

Downview - Flat Panel Display & CRT Monitor

Maximum dimensions for flat panel display-

18x18 view port: 17"W x 18"H (432mm W x 457.2mm H)

21x21 view port: 20½"W x 19" H (511mm W x 483mm H)

Maximum dimensions for CRT monitor-

18x21 view port: 17½"D x 17"W x 18"H (444mm D x 432mm W x 457mm H)

21x24 view port: 23½"D x 20½"W x 19" H (597mm D x 511mm W x 483mm H)

- Keeps monitor under glass below work surface
- Allows for multi-use working and learning environments
- Proven to be ergonomically beneficial, increase productivity
- Saves premium classroom and desktop space
- Hides confidential information
- Creates a clean, uncluttered look in the classroom or office
- Reduces the risk of damage to computer equipment

Surface Mount Flat Panel Display

Maximum weight for flat panel display: 21 lbs.

Maximum dimensions for flat panel display: Up to 24" diagonal wide screen

- Allows for multi-use working and learning environments
- Proven to be ergonomically beneficial, increase productivity
- Saves premium classroom and desktop space
- Creates a clean, uncluttered look in the classroom or office
- Reduces the risk of damage to computer equipment
- Height and tilt adjustable

Model Number Structure:



85-SD243630RX

85 -
Series

SD
Type

SD-Single desk
 DD-Double desk
 AD-ADA Compliant
 ST-Split top

243630
Size
D x W x H

R
CPU Location

R-Right
 L-Left

X
CPU Door Indicator

X-No Locking CPU Door
 D-With Locking CPU Door

NOTE:

See full listing of all "types" and last two letters on page 41.

Grommets

Grommets are rectangular black plastic.

Work Surface Edge Detail

Postform edge



To order, specify:

1. Model number
2. Colors for laminate base and work surface
3. Optional-Select visual display options
4. Optional-Select essential accessory options

Workstations-Monitor LEFT

**Monitor LEFT
CPU storage right**
For right-handed users

Suggested Keyboard Width:	*CPU Storage Width:
30W Unit = 28" KB	30W Unit = 7-7/8"
32W Unit = 30" KB	32W Unit = 9-7/8"
36W Unit = 34" KB	36W Unit = 11-1/4"
42W Unit = 34" KB	42W Unit = 14-7/8"
48W Unit = 34" KB	48W Unit = 20-7/8"



- Available with contoured end panels (Specify "S")
- Available with castors (Specify "C")

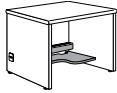

D x W x H (in.)	ft ³ / lbs	Model	List Price
24 x 30 x 30	13 / 109	85-SD243030RX	\$622
24 x 32 x 30	13 / 111	85-SD243230RX	\$646
24 x 36 x 30	15 / 113	85-SD243630RX	\$680
24 x 42 x 30	18 / 117	85-SD244230RX	\$835
24 x 48 x 30	20 / 125	85-SD244830RX	\$903
30 x 30 x 30	16 / 117	85-SD303030RX	\$664
30 x 32 x 30	17 / 119	85-SD303230RX	\$698
30 x 36 x 30	19 / 123	85-SD303630RX	\$707
30 x 42 x 30	22 / 131	85-SD304230RX	\$894
30 x 48 x 30	25 / 154	85-SD304830RX	\$960
36 x 36 x 30	23 / 144	85-SD363630RX	\$973
36 x 42 x 30	26 / 158	85-SD364230RX	\$1,073
36 x 48 x 30	30 / 210	85-SD364830RX	\$1,136

Visual Display Options available:

- The Trolley™ E-Class or H-Class
- Downview-Flat Panel Display
- Surface Mount Flat Panel Display
- Downview-CRT Monitor

*Adding a 21" x 21" visual display option may affect CPU storage widths.

Elementary Workstations Monitor RIGHT

**Monitor RIGHT
CPU storage left**
For left-handed users

Suggested Keyboard Width:	*CPU Storage Width:
30W Unit = 28" KB	30W Unit = 7-7/8"
32W Unit = 30" KB	32W Unit = 9-7/8"



- Available with contoured end panels (Specify "S")

D x W x H (in.)	ft ³ / lbs	Model	List Price
24 x 30 x 27	11 / 107	85-SD243027LX	\$559
24 x 32 x 27	12 / 109	85-SD243227LX	\$602
24 x 36 x 27	14 / 111	85-SD243627LX	\$634
24 x 42 x 27	16 / 115	85-SD244227LX	\$781
24 x 48 x 27	18 / 123	85-SD244827LX	\$838
30 x 30 x 27	15 / 114	85-SD303027LX	\$664
30 x 32 x 27	16 / 116	85-SD303227LX	\$698
30 x 36 x 27	18 / 120	85-SD303627LX	\$707
30 x 42 x 27	21 / 128	85-SD304227LX	\$894
30 x 48 x 27	24 / 151	85-SD304827LX	\$960

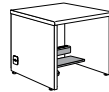

Workstations-Monitor RIGHT

**Monitor RIGHT
CPU storage left**
For left-handed users

Suggested Keyboard Width:	*CPU Storage Width:
30W Unit = 28" KB	30W Unit = 7-7/8"
32W Unit = 30" KB	32W Unit = 9-7/8"
36W Unit = 34" KB	36W Unit = 11-1/4"
42W Unit = 34" KB	42W Unit = 14-7/8"
48W Unit = 34" KB	48W Unit = 20-7/8"



- Available with contoured end panels (Specify "S")
- Available with castors (Specify "C")

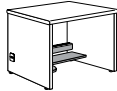

D x W x H (in.)	ft ³ / lbs	Model	List Price
24 x 30 x 30	13 / 109	85-SD243030LX	\$622
24 x 32 x 30	13 / 111	85-SD243230LX	\$646
24 x 36 x 30	15 / 113	85-SD243630LX	\$680
24 x 42 x 30	18 / 117	85-SD244230LX	\$835
24 x 48 x 30	18 / 117	85-SD244830LX	\$903
30 x 30 x 30	16 / 117	85-SD303030LX	\$664
30 x 32 x 30	17 / 119	85-SD303230LX	\$698
30 x 36 x 30	19 / 123	85-SD303630LX	\$707
30 x 42 x 30	22 / 131	85-SD304230LX	\$894
30 x 48 x 30	25 / 154	85-SD304830LX	\$960
36 x 36 x 30	23 / 144	85-SD363630LX	\$973
36 x 42 x 30	26 / 158	85-SD364230LX	\$1,073
36 x 48 x 30	30 / 210	85-SD364830LX	\$1,136

**Monitor CENTER
CPU storage right**
For right-handed users

Suggested Keyboard Width:	CPU Storage Width:
34"	10-1/8"



- Available with contoured end panels (Specify "S")
- Available with castors (Specify "C")

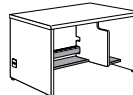

D x W x H (in.)	ft ³ / lbs	Model	List Price
24 x 48 x 30	20 / 125	85-SD244830XC	\$903
30 x 48 x 30	25 / 156	85-SD304830XC	\$960
36 x 48 x 30	30 / 213	85-SD364830XC	\$1,136

ADA Compliant Workstation - Monitor CENTER

**Monitor CENTER
CPU storage right**
For right-handed users

Suggested Keyboard Width:	CPU Storage Width:
34"	10-1/8"

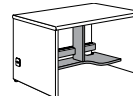

D x W x H (in.)	ft ³ / lbs	Model	List Price
30 x 48 x 32	27 / 160	85-AD304832RXC	\$1,045

Elementary Workstations Monitor LEFT

**Monitor LEFT
CPU storage right**
For right-handed users

Suggested Keyboard Width:	*CPU Storage Width:
30W Unit = 28" KB	30W Unit = 7-7/8"
32W Unit = 30" KB	32W Unit = 9-7/8"
36W Unit = 34" KB	36W Unit = 11-1/4"
42W Unit = 34" KB	42W Unit = 14-7/8"
48W Unit = 34" KB	48W Unit = 20-7/8"



- Available with contoured end panels (Specify "S")

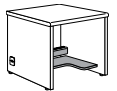

D x W x H (in.)	ft ³ / lbs	Model	List Price
24 x 30 x 27	11 / 107	85-SD243027RX	\$559
24 x 32 x 27	12 / 109	85-SD243227RX	\$602
24 x 36 x 27	14 / 111	85-SD243627RX	\$634
24 x 42 x 27	16 / 115	85-SD244227RX	\$781
24 x 48 x 27	18 / 123	85-SD244827RX	\$838
30 x 30 x 27	15 / 114	85-SD303027RX	\$664
30 x 32 x 27	16 / 116	85-SD303227RX	\$698
30 x 36 x 27	18 / 120	85-SD303627RX	\$707
30 x 42 x 27	21 / 128	85-SD304227RX	\$894
30 x 48 x 27	24 / 151	85-SD304827RX	\$960

Workstations - Monitor LEFT With Locking Doors

**Monitor LEFT
CPU storage right**
For right-handed users

Suggested Keyboard Width:	*CPU Storage Width:
34"	36W Unit = 11-1/4"
	42W Unit = 14-7/8"
	48W Unit = 20-7/8"

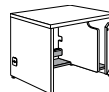

- Available with castors (Specify "C")

D x W x H (in.)	ft ³ / lbs	Model	List Price
24 x 36 x 30	15 / 115	85-SD243630RD	\$940
24 x 42 x 30	18 / 119	85-SD244230RD	\$1,128
24 x 48 x 30	20 / 127	85-SD244830RD	\$1,159
30 x 36 x 30	19 / 125	85-SD303630RD	\$995
30 x 42 x 30	22 / 133	85-SD304230RD	\$1,183
30 x 48 x 30	25 / 156	85-SD304830RD	\$1,213
36 x 36 x 30	23 / 146	85-SD363630RD	\$1,215
36 x 42 x 30	26 / 160	85-SD364230RD	\$1,422
36 x 48 x 30	30 / 212	85-SD364830RD	\$1,449

Post form edge, high pressure laminate top and base

85 Series

 **ASSEMBLY REQUIRED**

* Adding a 21" x 21" visual display option may affect CPU storage widths.

How To Order

1. Select model number

Ex: 85-SD243630RX

- A select offering of **left-handed units** are listed. For additional left-handed units, call Customer Support: 1-800-730-6682.
- For **ADA Height** unit, change height from 30 to **32** in model number and add \$80 for single desk and \$120 for double desk. Ex: 85-SD2436**32**RX

2. Select laminate colors for base and work surface (see page 144)

Ex: 227 044
base work
surface

3. Optional-Select visual display options (see page 115)

Ex: TH0721NK (The Trolley H-Class with Nova keyboard drawer)

4. Optional-Select essential accessory options (see page 34)

Ex: 11205DP (Standard data port)

- All locking units can be keyed alike. Please note on purchase order.

Workstations - Monitor CENTER With Locking Doors

Monitor CENTER CPU storage right
For right-handed users

Suggested Keyboard Width: 34"
CPU Storage Width: 10-1/8"
Interior Depth of CPU Storage: 24" D Unit only = 18-9/16"

- Available with castors (Specify "C")

D x W x H (in.)	ft ³ / lbs	Model	List Price
24 x 48 x 30	20 / 127	85-SD244830RDC	\$1,159
30 x 48 x 30	25 / 158	85-SD304830RDC	\$1,213
36 x 48 x 30	30 / 215	85-SD364830RDC	\$1,449

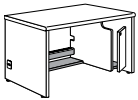

Double Monitor Workstations Monitors LEFT

Monitor LEFT in workspace CPU storage right
For (2) right-handed users

Suggested Keyboard Width: 59W Unit: 28" KB
63W Unit: 30" KB
71W Unit: 34" KB
**CPU Storage Width:* 59W Unit: 7-7/8"
63W Unit: 9-9/16"
71W Unit: 12"

- Available with contoured end panels. (Specify "S")

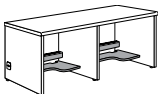

24 x 59 x 30	25 / 210	85-DD245930RX	\$1,194
24 x 63 x 30	26 / 214	85-DD246330RX	\$1,243
24 x 71 x 30	30 / 218	85-DD247130RX	\$1,311
30 x 59 x 30	31 / 217	85-DD305930RX	\$1,280
30 x 63 x 30	33 / 221	85-DD306330RX	\$1,346
30 x 71 x 30	37 / 225	85-DD307130RX	\$1,365
36 x 71 x 30	44 / 263	85-DD367130RX	\$1,690

Double Monitor Workstations Monitors RIGHT

Monitor RIGHT in workspace CPU storage left
For (2) left-handed users

Suggested Keyboard Width: 59W Unit: 28" KB
63W Unit: 30" KB
71W Unit: 34" KB
**CPU Storage Width:* 59W Unit: 7-7/8"
63W Unit: 9-9/16"
71W Unit: 12"

- Available with contoured end panels (Specify "S")

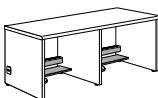

24 x 59 x 30	25 / 210	85-DD245930LX	\$1,194
24 x 63 x 30	26 / 214	85-DD246330LX	\$1,243
24 x 71 x 30	30 / 218	85-DD247130LX	\$1,311
30 x 59 x 30	31 / 217	85-DD305930LX	\$1,280
30 x 63 x 30	33 / 221	85-DD306330LX	\$1,346
30 x 71 x 30	37 / 225	85-DD307130LX	\$1,365
36 x 71 x 30	44 / 263	85-DD367130LX	\$1,690

Double Monitor Workstations Monitors LEFT - With Locking Doors

Monitor LEFT in workspace CPU storage right
For (2) right-handed users

Suggested Keyboard Width: 34"
CPU Storage Width: 12-5/8"
Interior Depth of CPU Storage: 24" D Unit only = 18-9/16"

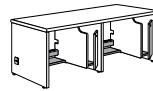

D x W x H (in.)	ft ³ / lbs	Model	List Price
24 x 71 x 30	30 / 222	85-DD247130RD	\$1,565
30 x 71 x 30	37 / 229	85-DD307130RD	\$1,620
36 x 71 x 30	44 / 267	85-DD367130RD	\$2,286

Double Monitor Workstations Monitors RIGHT - With Locking Doors

Monitor RIGHT in workspace CPU storage left
For (2) left-handed user

Suggested Keyboard Width: 34"
CPU Storage Width: 12-5/8"
Interior Depth of CPU Storage: 24" D Unit only = 18-9/16"

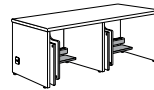

24 x 71 x 30	30 / 222	85-DD247130LD	\$1,565
30 x 71 x 30	37 / 229	85-DD307130LD	\$1,620
36 x 71 x 30	44 / 267	85-DD367130LD	\$2,286

Stand-Up Teacher's Desks

Stand-Up Unit Monitor LEFT CPU storage right
For right-handed users

Suggested Keyboard Width: 34"
**CPU Storage Width:* 36W Unit = 11-1/4"
42W Unit = 14-7/8"
48W Unit = 20-7/8"

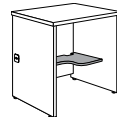

- Available with castors (Specify "C")
- Available with Drop Leaf Shelf. For factory prep, must specify "U" for left-handed or "V" for right-handed placement.

24 x 36 x 40	20 / 125	85-SD243640RX	\$872
24 x 42 x 40	23 / 129	85-SD244240RX	\$1,022
24 x 48 x 40	27 / 137	85-SD244840RX	\$1,070
30 x 36 x 40	25 / 139	85-SD303640RX	\$918
30 x 42 x 40	29 / 147	85-SD304240RX	\$1,068
30 x 48 x 40	33 / 170	85-SD304840RX	\$1,117
36 x 36 x 40	30 / 162	85-SD363640RX	\$1,207
36 x 42 x 40	35 / 176	85-SD364240RX	\$1,262
36 x 48 x 40	40 / 228	85-SD364840RX	\$1,318

Multimedia Unit Monitor LEFT CPU storage right
Storage drawer
For right-handed users

Total access rear panel included. All drawers locking, rear access door on 42" & 48" wide models.

Suggested Keyboard Width: 36W Unit = 34" KB
42W Unit = 28" KB
48W Unit = 28" KB
**CPU Storage Width:* 36W Unit = 12-5/8"
42W Unit = 11"
48W Unit = 17"

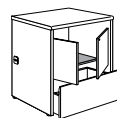

- Available with castors (Specify "C")
- Available with Drop Leaf Shelf. For factory prep, must specify "U" for left-handed or "V" for right-handed placement.

24 x 36 x 40	20 / 194	85-MM243640RD	\$1,556
30 x 36 x 40	25 / 196	85-MM303640RD	\$1,602
36 x 36 x 40	30 / 231	85-MM363640RD	\$1,796

2 adjustable shelves, 1 fixed shelf.

24 x 42 x 40	23 / 212	85-MM244240RD	\$1,894
24 x 48 x 40	27 / 224	85-MM244840RD	\$1,960
24 x 60 x 40	33.3 / 248	85-MM246040RD	\$2,195
30 x 42 x 40	29 / 294	85-MM304240RD	\$1,941
30 x 48 x 40	33 / 306	85-MM304840RD	\$2,006
30 x 60 x 40	41.6 / 330	85-MM306040RD	\$2,247
36 x 42 x 40	35 / 323	85-MM364240RD	\$2,211
36 x 48 x 40	40 / 375	85-MM364840RD	\$2,221

To order, specify:

1. Model number
2. Colors for laminate base and work surface
3. Optional-Select visual display options
4. Optional-Select essential accessory options

Split Top Workstations

**Monitor LEFT
CPU storage right**
For right-handed users

D x W x H (in.)	ft ³ / lbs	Model	List Price
-----------------	-----------------------	-------	------------

Suggested Keyboard Width: 34"
**CPU Storage Width:*
36W Unit = 11-1/4"
42W Unit = 14-7/8"
48W Unit = 10-1/8"
60W Unit = 16-1/8"
66W Unit = 19-1/8"

• Available with castors (Specify "C")

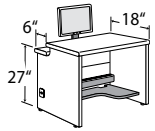

6" D x 27" H shelf intended for a flat panel monitor with base.			
24 x 36 x 30	19 / 123	85-ST243630RX	\$877
24 x 42 x 30	22 / 131	85-ST244230RX	\$1,092
24 x 48 x 30	25 / 154	85-ST244830RX	\$1,168
24 x 60 x 30	31 / 197	85-ST246030RX	\$1,292
24 x 66 x 30	34 / 218	85-ST246630RX	\$1,380

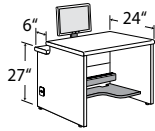

30 x 36 x 30	19 / 123	85-ST303630RX	\$934
30 x 42 x 30	22 / 131	85-ST304230RX	\$1,149
30 x 48 x 30	25 / 154	85-ST304830RX	\$1,225
30 x 60 x 30	31 / 197	85-ST306030RX	\$1,349
30 x 66 x 30	34 / 218	85-ST306630RX	\$1,437

Privacy Panels

**Privacy Panels
for Single Monitor
Workstation**

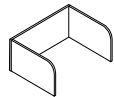

6" radius on front. Specify base color only. Field installed.

24 x 30 x 15	01 / 42	85-PP243015	\$284
24 x 32 x 15	01 / 42	85-PP243215	\$293
24 x 36 x 15	01 / 44	85-PP243615	\$303
24 x 42 x 15	02 / 47	85-PP244215	\$333
24 x 48 x 15	02 / 49	85-PP244815	\$367

30 x 30 x 15	01 / 45	85-PP303015	\$315
30 x 32 x 15	01 / 45	85-PP303215	\$326
30 x 36 x 15	02 / 47	85-PP303615	\$336
30 x 42 x 15	02 / 51	85-PP304215	\$370
30 x 48 x 15	02 / 54	85-PP304815	\$407

36 x 36 x 15	03 / 52	85-PP363615	\$377
36 x 42 x 15	03 / 55	85-PP364215	\$415
36 x 48 x 15	03 / 59	85-PP364815	\$454

**Privacy Panels
for Double Monitor
Workstation**

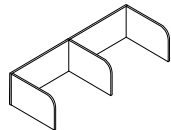

6" radius on front. Specify base color only. Field installed.

24 x 59 x 15	04 / 60	85-PP245915	\$426
24 x 63 x 15	04 / 63	85-PP246315	\$462
24 x 71 x 15	05 / 67	85-PP247115	\$520

30 x 59 x 15	04 / 63	85-PP305915	\$462
30 x 63 x 15	05 / 66	85-PP306315	\$509
30 x 71 x 15	05 / 72	85-PP307115	\$573

36 x 71 x 15	06 / 77	85-PP367115	\$620
--------------	---------	-------------	-------

Wedges

Wedges

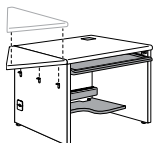

Hardware included. Assembly required.

For 24" D units

90 Degree - Includes end panels. Must specify base and work surface color.

24 x 33 ¹⁵ / ₁₆ x 30	85-WG24333090	\$408
--	---------------	-------

For 30" D units

90 Degree - Includes end panels. Must specify base and work surface color.

30 x 42 ³ / ₁₆ x 30	85-WG30423090	\$435
---	---------------	-------

For 36" D units

90 Degree - Includes end panels. Must specify base and work surface color.

36 x 50 ¹ / ₁₆ x 30	85-WG36503090	\$468
---	---------------	-------

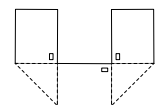

Visual Display Options available:

- The Trolley™ E-Class or H-Class
- Downview-Flat Panel Display
- Surface Mount Flat Panel Display
- Downview-CRT Monitor

*Adding a 21" x 21" visual display option may affect CPU storage widths.

Miscellaneous

D x W x H (in.)	ft ³ / lbs	Model	List Price
-----------------	-----------------------	-------	------------

Contoured end panels



Available on specified units.

-S	\$80/Single desk
	\$120/Double desk

Castors

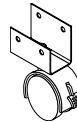

For Training desks.

With stabilization bracket. Available on specified units. When adding castors, the total height of the workstation will not change.

Set of 4 (Available on single wide workstations only)

2 ⁵ / ₈ x 1 ³ / ₄ x 3 ¹ / ₄	-C	\$80/set
---	----	----------

Heavy-duty rugged castors for stand-up or multimedia units. With stabilization bracket. Available on specified units. When adding castors (-C) to stand-up or multimedia units, the total height of the unit will increase by 2-3/4".

3 ¹ / ₂ x 03 x 04	-C	\$300/set
---	----	-----------

Drop leaf shelf



Shipped Separately. Color matches work surface of desk ordered. Located 3" down from work surface.

Attaches to the LEFT side panel of Multimedia or Stand-up units.

22 x 15 x 01	8.39 / 98.3	85-SH221501L	\$420
--------------	-------------	--------------	-------

Attaches to the RIGHT side panel of Multimedia or Stand-up units.

22 x 15 x 01	8.39 / 98.3	85-SH221501R	\$420
--------------	-------------	--------------	-------

Rectangular Wire Grommet



Black plastic grommet cover is removable for easy wire management. If installed (available for work surface only):

Please provide sketch to indicate placement location

1 ⁷ / ₈ x 3 ¹ / ₄ x 1 ¹ / ₄ (cutout dimensions)	WG1080	\$58
---	--------	------

If Sold Separately (not part of base model):

1 ⁷ / ₈ x 3 ¹ / ₄ x 1 ¹ / ₄ (cutout dimensions)	AC-WG1080	\$29
---	-----------	------

For other grommet options, see page 35.

Factory Installed Keyboard Options Only for 85 Series

(Only ordered when NO Visual Display Options ordered)

Factory Installed Nova Keyboard

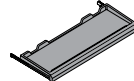

Keyboard length to fit casegoods ordered

22" - 34" wide	NK	\$100
----------------	----	-------

Factory Installed Center Mount Articulating Keyboard Mechanism & Tray

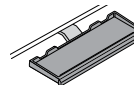

Keyboard length to fit casegoods ordered

22" - 34" wide	CK	\$210
----------------	----	-------

Factory Installed Dual-Mount Adjustable Keyboard Tray

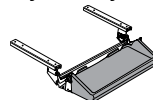

Keyboard length to fit casegoods ordered

22" - 34" wide	AK	\$285
----------------	----	-------

Hardwiring



How To Order - Hardwire-Standard Workstation

1. Select a standard workstation, and add -W to the end of the model number
2. Complete room layout with workstations
3. Select power entry
4. Select jumper length
5. Select receptacle block
6. Select mounting bracket quantities for all receptacle blocks.

NOTE: Mounting brackets with receptacle block always located behind CPU storage.

Standard Features

4-wires, 2 circuits, 20 Amps each (Circuit 1 and 2 only)
 13-Duplex receptacles per circuit, 26-15 Amp Duplex receptacles per power infeed maximum
 Easy to specify
 Easy to install and reconfigure
 Requires less space
 UL Listed as a Manufactured Wiring System
 More economical than 8-Wire System

Electrical Components

D x W x H (in.)	Model	List Price
Receptacle Block		
Complete the model number by indicating it's circuit number (1 circuit or 2 circuit). Example: a receptacle block for a 1-circuit would be model number BE41917-3-A-_-8B.		
	BE41917-3-A-_-8B	\$95

Receptacle to Receptacle Block Connector	BE41919-3	\$21
---	-----------	------



4-Way "H" Connector	BE41921-3	\$34
----------------------------	-----------	------



Transition wall plate, Rotating power entry	BE42171-3-06	\$146
--	--------------	-------

Spring clip mounting bracket with Screws	BE41955	\$5
---	---------	-----



Power entry with RH Plug		
24" Power Entry, Circuit 1, 12" 20A Cord, RA Plug	BE42087-3-1-RA-24	\$289
36" Power Entry, Circuit 1, 24" 20A Cord, RA Plug	BE42087-3-1-RA-36	\$296
48" Power Entry, Circuit 1, 24" 20A Cord, RA Plug	BE42087-3-1-RA-48	\$303
60" Power Entry, Circuit 1, 24" 20A Cord, RA Plug	BE42087-3-1-RA-60	\$310
72" Power Entry, Circuit 1, 24" 20A Cord, RA Plug	BE42087-3-1-RA-72	\$316
96" Power Entry, Circuit 1, 24" 20A Cord, RA Plug	BE42087-3-1-RA-96	\$460

Female to Female Jumper



D x W x H (in.)	Model	List Price
6" W	BE41920-3-6	\$85
12" W	BE41920-3-12	\$92
18" W	BE41920-3-18	\$99
22" W	BE41920-3-22	\$103
24" W	BE41920-3-24	\$106
30" W	BE41920-3-30	\$112
36" W	BE41920-3-36	\$119
42" W	BE41920-3-42	\$126
48" W	BE41920-3-48	\$138
54" W	BE41920-3-54	\$146
60" W	BE41920-3-60	\$154
66" W	BE41920-3-66	\$162
72" W	BE41920-3-72	\$169
78" W	BE41920-3-78	\$177
84" W	BE41920-3-84	\$185
90" W	BE41920-3-90	\$193
96" W	BE41920-3-96	\$200
102" W	BE41920-3-102	\$208
108" W	BE41920-3-108	\$216
114" W	BE41920-3-114	\$224
120" W	BE41920-3-120	\$231
126" W	BE41920-3-126	\$239
132" W	BE41920-3-132	\$247
138" W	BE41920-3-138	\$255
144" W	BE41920-3-144	\$262

Power Entry



36" W	BE41922-3-36	\$152
42" W	BE41922-3-42	\$159
48" W	BE41922-3-48	\$172
54" W	BE41922-3-54	\$180
60" W	BE41922-3-60	\$187
66" W	BE41922-3-66	\$195
72" W	BE41922-3-72	\$203
78" W	BE41922-3-78	\$211
84" W	BE41922-3-84	\$218
90" W	BE41922-3-90	\$226
96" W	BE41922-3-96	\$234
102" W	BE41922-3-102	\$242
108" W	BE41922-3-108	\$249
114" W	BE41922-3-114	\$257
120" W	BE41922-3-120	\$265
126" W	BE41922-3-126	\$273
132" W	BE41922-3-132	\$280
138" W	BE41922-3-138	\$288
144" W	BE41922-3-144	\$296

Refer to our website for hardwiring guide.
www.novadesk.com

To order, specify:

1. Model number
2. Colors for laminate base and work surface
3. Optional-Select visual display options
4. Optional-Select essential accessory options

Visual Display Options available:

- The Trolley™ E-Class or H-Class
 - Downview-Flat Panel Display
 - Surface Mount Flat Panel Display
 - Downview-CRT Monitor
- * Adding a 21" x 21" visual display option may affect CPU storage widths.*

Visual Display Options for 85 Series

Adding a visual display option does not affect Quick Ship lead times.
 Factory installed keyboard-only option for 85 series available on page 113.

Single monitor workstations require one (1) visual display option. Double monitor workstations require two (2) visual display options.

The Trolley™

Maximum dimensions for flat panel display:

- E-Class — 2¾" D x 18½" W x 14" H (70mm D x 470mm W x 356mm H)
- H-Class — 2¾" D x 16¼" W x 14" H (70mm D x 413mm W x 356mm H)

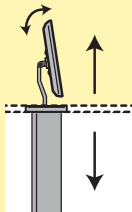

NOTE: Maximum distance from center of wall mount VESA plate to bottom of monitor is 6 ¾" (171mm)

Model	Wt.	List Price
E-Class with Nova Keyboard Drawer Trolley does not come installed in any unit, Nova Keyboard Drawer installed in assembled units only.		
TE0721NK	39	\$1,160
E-Class with Center Mount Articulating Keyboard Mechanism and Tray Trolley does not come installed in any unit, Center Mount Keyboard Tray installed in assembled units only.		
TE0721CK	41	\$1,330
H-Class with Nova Keyboard Drawer Trolley does not come installed in any unit, Nova Keyboard Drawer installed in assembled units only.		
TH0721NK	39	\$860
H-Class with Center Mount Articulating Keyboard Mechanism and Tray Trolley does not come installed in any unit, Center Mount Keyboard Tray installed in assembled units only.		
TH0721CK	41	\$1,030

- Optional keyboard choices
- E-Class suitable for flat panel displays up to 21" (diagonal)
- H-Class suitable for flat panel displays up to 19" (diagonal)
- One-touch activation
- Low voltage motor to lift & lower monitor
- Keyed lock for added security
- Provides vertical tilt adjustment in "up" position
- Durable metal enclosure under desktop
- Wire management system and power strip included

Downview-Flat Panel Display

Maximum dimensions for flat panel display:

- 18x18 view port: 17"W x 18" H (432mm W x 457.2mm H)
- 24" min. work surface depth
- 21x21 view port: 20 1/8"W x 19" H (511mm W x 483mm H)
- 30" min. work surface depth

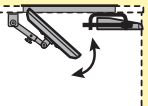

Model	Wt.	List Price
With Nova Keyboard Drawer Downview Flat Panel Display & Nova Keyboard Drawer installed in assembled units only.		
FPA1818NK	24	Includes 18" x 18" view port, adjustable arm, and visor. \$360
FPA2121NK	26	Includes 21" x 21" view port, adjustable arm, and visor. \$420
With Dual Mount Adjustable Keyboard Tray Downview Flat Panel Display & Dual Mount Keyboard Tray installed in assembled units only.		
FPA1818AK	25	Includes 18" x 18" view port, adjustable arm, and visor. \$605
FPA2121AK	27	Includes 21" x 21" view port, adjustable arm, and visor. \$665

- 18x18 view port suitable for flat panel displays up to 19" diagonal
- 21x21 view port suitable for flat panel displays up to 21" diagonal
- Tinted, tempered glass viewport
- Keeps monitor under glass below work surface
- Wire management system and power strip included

Surface Mount Flat Panel Display

Maximum weight for flat panel display: 21 lbs.
 Dimensions for flat panel display:
 Up to 24" diagonal wide screen

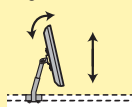

Model	Wt.	List Price
With Nova Keyboard Drawer Surface Mount Flat Panel Display does not come installed in any unit, Nova Keyboard Drawer installed in assembled units only.		
SMA0203NK	13	\$260
With Center Mount Articulating Keyboard Mechanism and Tray Surface Mount Flat Panel Display does not come installed in any unit, Center Mount Keyboard Tray installed in assembled units only.		
SMA0203CK	15	\$430

- Available in Learning Solutions series
- Optional keyboard choices
- Suitable for flat panel displays up to 24" diagonal wide screen
- Wire management system and power strip included

Downview - CRT Monitor

Maximum dimensions for CRT monitor:

- 18x21 view port: 17½"D x 17"W x 18" H (444mm D x 432mm W x 457.2mm H)
- 27" min. work surface depth
- 21x24 view port: 23½"D x 20 1/8"W x 19" H (597mm D x 511mm W x 483mm H)
- 36" min. work surface depth

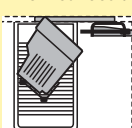

Model	Wt.	List Price
With Nova Keyboard Drawer Downview CRT Monitor & Nova Keyboard Drawer installed in assembled units only.		
CRT1821NK	57-61	Includes 18" x 21" view port, CRT support system, and visor. \$360
CRT2124NK	59-63	Includes 21" x 24" view port, CRT support system, and visor. \$438
With Dual Mount Adjustable Keyboard Tray Downview CRT Monitor & Dual Mount Keyboard Tray installed in assembled units only.		
CRT1821AK	58-62	Includes 18" x 21" view port, CRT support system, and visor. \$605
CRT2124AK	60-64	Includes 21" x 24" view port, CRT support system, and visor. \$683

- 18x21 view port suitable for CRT monitors up to 17" diagonal
- 21x24 view port suitable for CRT monitors up to 21" diagonal
- Tinted, tempered glass view port
- Keeps monitor under glass below work surface
- Wire management system and power strip included

For details and installation specifications, refer to pages 132-138.

Custom Solutions

For drawing, specification and pricing assistance for your custom arc configuration, please contact Nova's Customer Support
1-800-730-6682

Conferencing

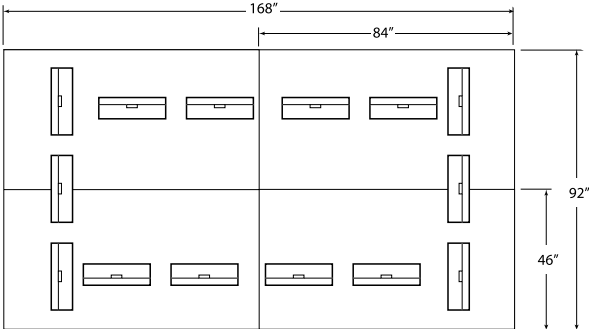
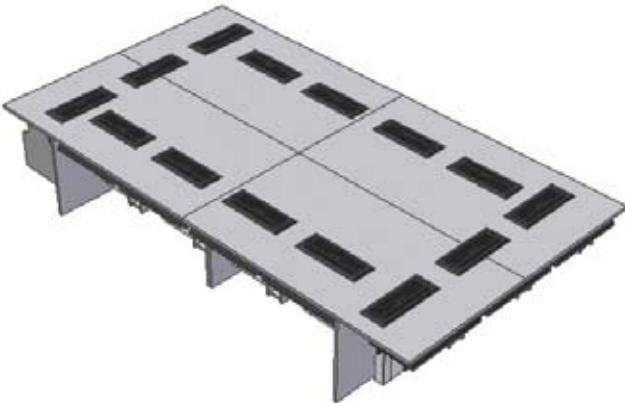

Auditoriums

